

**AMATEUR RADIO EXAMINATION
- QUESTION PAPER -**

INDEX NO.	AMR-2-2010-								
IC NO.			-						

IC COLOUR
KUNING

DAY : SUNDAY
DATE : 21st FEBRUARY 2010M / 7 RABIULAWAL 1431H
TIME : 0930 - 1130 (2 HOURS)
VENUE : MULTIPURPOSE HALL, UNIVERSITI BRUNEI DARUSSALAM

**TO ALL CANDIDATES
PLEASE READ CAREFULLY THE INSTRUCTIONS BELOW
BEFORE YOU START YOUR EXAMINATION PAPER**

1. This examination paper contains **60 multiple choice questions** and is separated into 2 sections. Section A contains **30 multiple choice questions**, and Section B also contains **30 multiple choice questions**, please answer all.
2. To answer, please **circle** the letters A, B, C or D that have been provided in the Answer Sheet.
3. Participants need to pass in both sections (Section A and B). Failure in either section will be counted as an automatic Fail.
4. Allowed writing material is **BLUE** or **BLACK** pens only. Pencils and other writing materials are prohibited.
5. **Strike** answers that are to be changed. The use of erasers, blanco or the likes is prohibited.
6. Mathematical work is allowed only on the question paper. Doing mathematical work on other paper is **prohibited**.
7. Examination Paper and Answer Sheet are to be returned to the invigilator, even if no questions are answered.
8. Participants are **prohibited** to speak, borrow writing materials or calculators or the likes during the whole duration of the exam.
9. Identification Card or passport is to be placed on the table for the whole duration of the examination. Participants are not allowed to leave their seats without permission from invigilators.
10. If it is found that participants are not following instructions, orders or warnings during the examination, their names will be recorded for further action or immediate disqualification.

SECTION A

This section contains 30 questions. Answer all.

1. Section 68 of the Telecommunication Order 2001 states that any person who establishes, installs, maintains, provides or operates a telecommunication system or service within Brunei Darussalam without a license granted shall be guilty of an offence. Which of the following statement of conviction is CORRECT should a person do commit an offence?
 - A. Any person guilty of an offence under this Order or any regulations made thereunder for which no penalty is expressly provided shall, in addition to the forfeiture of any article seized, be liable on conviction to a fine not exceeding \$30,000, imprisonment for a term not exceeding 1 years of both.
 - B. Any person guilty of an offence under this Order or any regulations made thereunder for which no penalty is expressly provided shall, in addition to the forfeiture of any article seized, be liable on conviction to a fine not exceeding \$10,000, imprisonment for a term not exceeding 3 years of both.
 - C. Any person guilty of an offence under this Order or any regulations made thereunder for which no penalty is expressly provided shall, in addition to the forfeiture of any article seized, be liable on conviction to a fine not exceeding \$1,000, imprisonment for a term not exceeding 3 years of both.
 - D. No fine is liable at all.

2. In what Region and Zone is Brunei Darussalam located?
 - A. Region 3, Zone 28
 - B. Region 28, Zone 3
 - C. Region 38, Zone 2
 - D. Region 2, Zone 38

3. If you purchase amateur radio equipment from outside the country, what is the right thing to do upon arrival at the custom's control post?
 - A. Bring in the said equipment without notifying Royal Brunei Custom and Excise Officials and seek approval from AITI
 - B. Declare the equipment to the Royal Brunei Custom and Excise officials, seek approval from AITI and pay import tax for the equipment
 - C. Pay import tax for the equipment without seeking approval from AITI
 - D. Bring the equipment directly to AITI officials for approvals without having to pay for import tax.

4. What are the complete details inside the logbook for amateur radio operators everytime they are on air?
 - A. Duration of conversation time, station callsign which with you are communicating with, frequency band and emission.
 - B. Duration of conversation time, station which with you are communicating with, frequency band, emission and power output, signal report, QSL.
 - C. Date, frequency band and emission, power output, conversation time, signal report, statement.
 - D. Date, frequency band and emission, power output, station callsign which you are communicating with, start and end of conversation time, signal report, QSL.

5. With regards to AITI rules and regulation, amateur radio equipment is only permitted to be operated
 - A. Within the frequency range stated in the license
 - B. Within the permitted range of frequency in the radio equipment
 - C. The frequency range that has been issued by ITU.
 - D. Any frequency of your choice that you find suitable to communicate.

6. Which of the statement below is CORRECT regarding installation of amateur radio equipment in a premise?
 - A. One unit of licensed radio equipment is only allowed for one premise unless stated otherwise in the license.
 - B. Radio equipment can be installed in any premise without any valid amateur radio license.
 - C. Installation of radio equipment and antenna is not required to meet the specifications and regulations of building/residential code.
 - D. One unit of licensed radio equipment can be transferred anytime from one premise to another.

7. As a correct etiquette, you should stop your QSO immediately and take the emergency call, when you hear....
 - A. "MAYDAY MAYDAY"
 - B. "FORE FORE"
 - C. "STOP STOP"
 - D. "HELLO"

8. 'Aedy' is having an amateur radio conversation with 'Fauzi'. Which set of conversations below should they avoid:
 - A. Religion, Business, Politics, Racial and Ethnic Slurs.
 - B. Hobbies, Education, and Entertainment.
 - C. Sport, Personal details and Socializing.
 - D. Weather, Location and Q-Codes.

9. A station 'Callsign' is sent for the purpose of identification at the start of transmission and end of transmission. It should...
 - A. Be mentioned once after the first 60 minutes
 - B. Be mentioned once after the first 15 minutes
 - C. Be repeated every 15 minutes
 - D. Be repeated every 60 minutes

10. What is required by AITI during random amateur radio inspections?
 - A. Station Log Book and a valid amateur radio licence
 - B. Station log book and a certificate from Radio Organisation
 - C. Station log book and a valid driving licence
 - D. A certificate from any Radio Organisation and a valid driving licence

11. What is the validity period of an Import Permit for an Amateur Radio equipment from the date of issue?
 - A. 1 year
 - B. 1 month
 - C. 3 weeks
 - D. 14 days

12. What is the frequency band used by an amateur radio for a "Very High Frequency" in Brunei Darussalam?
 - A. 144.000 kHz – 148.000 kHz
 - B. 144.000 MHz – 148.025 MHz
 - C. 144.000 MHz – 148.000 MHz
 - D. 144.000 kHz – 148.025 kHz

13. For 15 meter band, which one of the following frequency band is correct?
 - A. 28.000 – 29.700 MHz
 - B. 21.000 – 21.450 MHz
 - C. 14.350 – 21.000 MHz
 - D. 15.000 – 15.450 MHz

14. What is the 'Q' code for "Are you busy?" and "Who's calling me?"
 - A. QRB and QRZ
 - B. QRL and QRM
 - C. QRB and QRM
 - D. QRL and QRZ

15. What does 'OM' and 'XYL' stands for?
 - A. Old Woman and Husband
 - B. Old Man and Wife
 - C. Old Man and Young Lady
 - D. Young Man and Young Lady

16. All amateur radio equipment in a station has to be maintained and used
 - A. Not to interfere with other radio-communication services
 - B. With support from IEE
 - C. Approximately 20% of the approved maximum power
 - D. With complete discretion by AITI officials

17. Amateur radio services, as a secondary service, are permitted to use the frequency band if
 - A. amateur radio user feels experienced enough
 - B. it only interferes with other primary services
 - C. it does not cause any interference to primary service
 - D. the primary service operates at a lower power and used at the same time

18. What is the correct callsign prefix for Standard and Advance Amateur Radio Licence respectively?
- A. V89 and V88
 - B. V88 and V89
 - C. V8N and V8M
 - D. V8B and V8A
19. To avoid a direction high gain antenna from directing its excess RF power to the people in nearby buildings, what must be done?
- A. Place the antenna higher than surrounding buildings.
 - B. All equipment must be properly grounded.
 - C. Place the antenna lower or equal height to the surrounding buildings.
 - D. None of the above
20. What is a transmission called that disturbs other communications?
- A. Interrupted CW
 - B. Harmful interference
 - C. Transponder signals
 - D. Unidentified transmissions
21. Which one of the following prefix is valid for Brunei Darussalam amateur callsign?
- A. V89, V88, V85
 - B. B89, B88, B85
 - C. V8A, V8B, V8M, V8N
 - D. V8V, 9W, 9M, V8L
22. The most common input/output frequency offset for repeaters in the 2-metre band is
- A. 1.6 MHz
 - B. 0.6 MHz
 - C. 5.0 MHz
 - D. 0.4 MHz
23. What is the meaning of the term simplex operation?
- A. Transmitting and receiving on the same frequency
 - B. Transmitting and receiving over a wide area
 - C. Transmitting on one frequency and receiving on another
 - D. Transmitting one-way communications
24. When starting to transmit using a repeater, you should
- A. Wait and listen before any communication.
 - B. Keying the repeater and not saying anything.
 - C. Keep the transmission lengthy.
 - D. Speak using jargons.

25. An amateur radio licensee should renew their licence every?
- A. No renewal required
 - B. 3 months
 - C. 12 months
 - D. 24 months
26. Under what conditions are amateur radio stations allowed to communicate with stations operating in other radio services?
- A. When communicating with space shuttle.
 - B. When in actual emergency.
 - C. When communicating with commercial radio station.
 - D. When other radio service is contacting amateur radio station.
27. Where does a Brunei Darussalam Amateur Radio licence allow you to transmit?
- A. From anywhere in the world
 - B. From wherever the Amateur Radio Service is regulated as stated in the licence issued
 - C. From a country that shares a third party agreement with Brunei Darussalam
 - D. Only from the mailing address printed on your license
28. In what circumstances can an amateur radio broadcast information to the public?
- A. When an amateur radio operator is paid
 - B. When broadcasting is less than one hour
 - C. When broadcasting is more than 15 minutes
 - D. It is entirely prohibited
29. What are the requirements for applying an Amateur Radio licence upgrade (ie. V89 – V88)?
- A. The licence holder must fill up the Amateur Radio Callsign Application form and submit a minimum six (6) month logbook.
 - B. Licence holder must hold a valid Amateur Radio licence for at least three (3) years
 - C. To purchase an amateur HF radio equipment before applying.
 - D. No further process required upon passing your amateur radio examination.
30. What type of interference may come from a multi-band antenna connected to a poorly tuned transmitter?
- A. Harmonic radiation
 - B. Auroral distortion
 - C. Parasitic excitation
 - D. Intermodulation noise





SECTION B

This section contains 30 questions. Answer **all**.

31. Current is define as

- A. a measure of electromotive (EMF) force between two points
- B. a measure of the flow of electrons through a conductor
- C. material property that opposes the flow of electrons
- D. the amount of energy per unit time expended by a system

32. What is the symbol for resistor

- A. 
- B. 
- C. 
- D. 

33. The relationships between, 'Voltage (V)', 'Resistor (R)' and 'Current (I)' is

- A. $V = IR$
- B. $V = R/I$
- C. $V = IR^2$
- D. $V = I^2R$

34. The current through a 2 k Ω resistor is 10 mA. What is the voltage across this resistor?

- A. 20 Volts
- B. 5 Volts
- C. 5 millivolts
- D. 50 Volts

35. For AC measurement, the value of Voltage-Root-Mean-Square (V_{rms}) is

- A. 0.707 peak voltage (V_{pk})
- B. 0.5 peak voltage (V_{pk})
- C. 1.0 peak voltage (V_{pk})
- D. 0.333 peak voltage (V_{pk})

36. If ' λ ' is wavelength, ' c ' is speed of light and ' f ' is frequency, which formula listed below is correct?

- A. $\lambda = fc$
- B. $f = \lambda/c$
- C. $c = f^2\lambda$
- D. $c = f\lambda$

37. What is the frequency of an alternating current if the time period is 0.25 μ s?

- A. 4.0 kHz
- B. 4.0 MHz
- C. 0.25 Hz
- D. 0.25 kHz

38. In the diagram below, indicate the current flow in the semi-conductor diode.

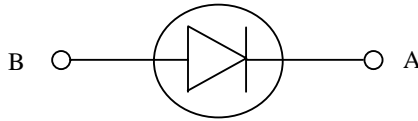

- A. From A to B
- B. From B to A
- C. From A to B and B to A
- D. None of the above

39. What is the frequency of the signal shown below at speed 3×10^8 m/s, if both half-cycle are of equal length?

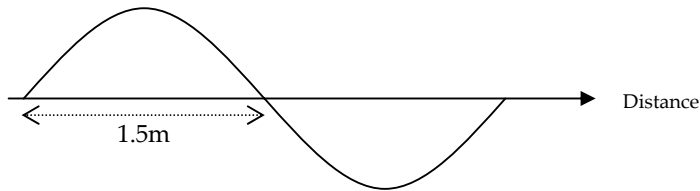

- A. 100 MHz
- B. 200 MHz
- C. 450 MHz
- D. 900 MHz

40.

Symbol transistor

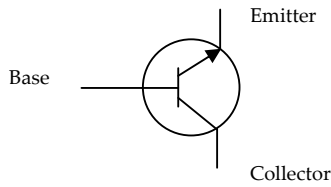

With reference to the transistor symbol above, which one is the correct answer?

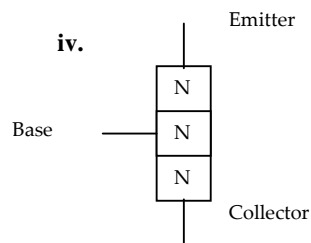
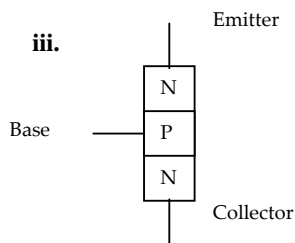
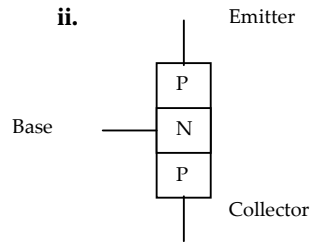
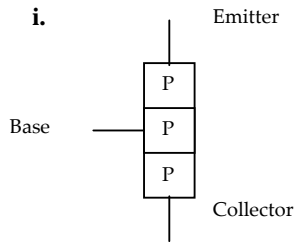

- A. i
- B. ii
- C. iii
- D. iv

41. Which of the following is false about Inductors?
- A. Store energy with a magnetic field in a coil of wire
 - B. Act as short for low frequencies, open circuit at high frequencies
 - C. Store energy with an electric field in parallel conductors
 - D. Used for filtering and smoothing of signals and are the major components in transformers

42. What is the current and total resistance of three resistors in the circuit shown below?

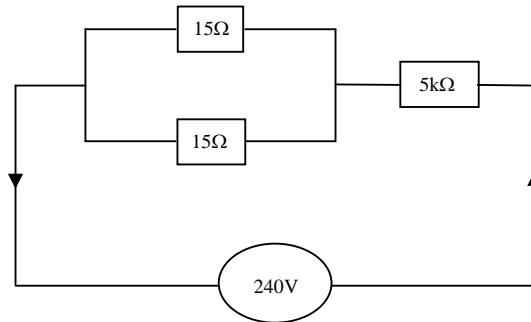

- A. 5007.5 Ohms and 240A
 - B. 5030 Ohms and 240 A
 - C. 5007.5 Ohms and 0.05 A
 - D. 5007.5 Ohms and 6.86A
43. According to Ampere's law, an electric current produces a
- A. Electric field
 - B. Magnetic field
 - C. Current field
 - D. Resistive field
44. What is the function of a fuse?
- A. Burns open at higher currents than fuse rating
 - B. Produce a voltage across its terminal that is proportional to electric current
 - C. Ground electrical equipment
 - D. Decrease the frequency of the power voltage
45. The main advantage of the yagi aerial as compared with dipole is
- A. Smaller physical dimensions
 - B. Increased forward gain
 - C. A wider beam width
 - D. A better match for the feeder
46. What is the ideal vertical antenna for $\frac{1}{4}$ wavelength for operating frequency of 146MHz?
- A. 0.5m
 - B. 5m
 - C. 50m
 - D. 30m

47. A power amplifier has a gain of 10. If you input 2W, the output would be?
- A. 0.2W
 - B. 20W
 - C. 100W
 - D. 5W
48. What does Single-sideband modulation (SSB) means?
- A. It is a refinement of the technique of amplitude modulation
 - B. It is a refinement of the technique of frequency modulation
 - C. It is a form of digital modulation
 - D. It is a spread spectrum modulation technique
49. Define the function of a Bandpass filter?
- A. Restrict high frequency
 - B. Restrict low frequency
 - C. Allow only data between two cutoff frequencies to pass
 - D. Allow data except between two cutoff frequencies to pass
50. What is the modulation used in "High Frequency" and "Very High Frequency" respectively?
- A. Single band and multiple band
 - B. Frequency modulation and amplitude modulation
 - C. Amplitude modulation and frequency modulation
 - D. Quadrature amplitude modulation and phase modulation
51. The transmission power for transmitting amateur radio must not exceed
- A. 150 Watts
 - B. 125 Watts
 - C. 75 Watts
 - D. 175 Watts
52. Groundwave is define as:
- A. radio waves traveling along the Earth's surface
 - B. radio waves that reflect off the ionosphere
 - C. radio waves that is absorb by the ground
 - D. none of the above
53. What is used to convert sounds from our voice into radio signals?
- A. Transmitter
 - B. Receiver
 - C. Speaker
 - D. Antenna
54. Radio Horizon is define as
- A. The line of sight between two transmissions
 - B. The communications done in coastal areas
 - C. The point where radio signals between two points are blocked by the curvature of the Earth
 - D. The communications to the space-station during ideal weather condition

55. The frequency band '3000 kHz – 30000 kHz ' is categorised under?
- Very high frequency
 - High frequency
 - Ultra high frequency
 - Low frequency
56. Define which antenna comprises of a center-fed driven element for transmitting or receiving radio frequency energy?
- Omni-directional Antenna
 - Half wavelength dipole
 - Yagi Antenna
 - Straight wire antenna
57. The purpose of a 2 meter repeater is to
- Provide amateur operation without the use of callsigns
 - Provide communication for emergency purposes
 - Make possible VHF contacts over longer distance
 - Experiment with frequency shift techniques
58. A standing wave meter (SWR) is used to check the
- Height of the tower
 - Efficiency of a transmitter
 - Resonant frequency of an aerial
 - Matching of the transmitter to the aerial system
59. Below is a diagram of a Half wavelength for a dipole antenna.

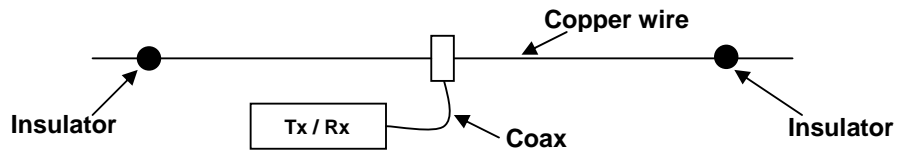

What is the length of the copper wire required for Half Wavelength dipole antenna for 20 meter on frequency 14230kHz?

- 16 ft 44 inch
- 14 ft 23 inch
- 14 ft 5 inch
- 7 ft 11.5 inch

60. Ionization in D layer as shown in figure .1, below has the following properties:

- A. Recombines quickly after sunset
- B. Can stay ionized long after sunset
- C. No properties change after sunset
- D. Disperse quickly after sunset

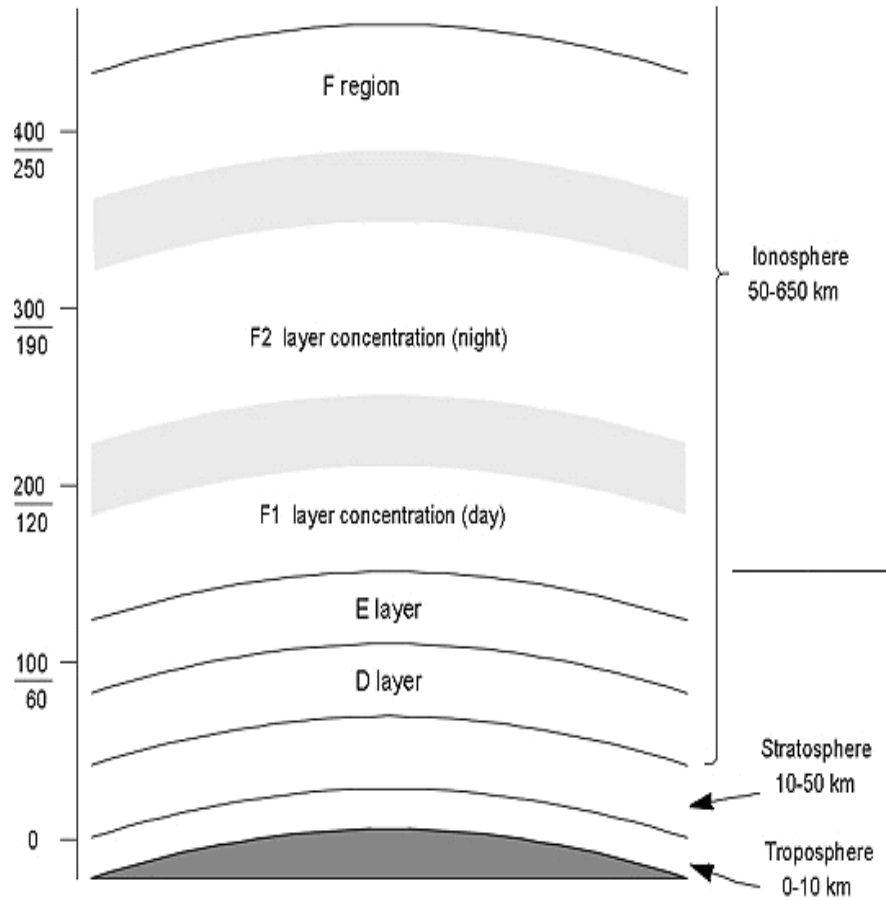

Figure .1